

**Safety and asset
protection achieved by
measuring oxygen in
inerting and blanket gas**

Ensuring plant personnel get home safely at the end of their shift and that the plant's neighbors are not adversely impacted by operations is every company's primary concern. In many plant operations, product is stored in tanks and other vessels. Hydrocarbon vapors may be found in the head space of these vessels. Similarly, hydrocarbon vapors may be found in reaction vessels, biomass storage vessels, and grain storage. The presence of oxygen along with an ignition source can lead to an explosion with devastating results and product loss.

This paper looks at the benefits of adding an oxygen measurement to purge systems that help mitigate the presence of explosive mixtures, thus ensuring an effective purge. Oxygen measurement can also help reduce cost, allowing the control system to use only the amount of nitrogen necessary to prevent a hazardous mixture.

Introduction

The benefit of purging the head space in a storage vessel with nitrogen to minimize the presence of volatile organic compounds and oxygen, thus mitigating the possibility of an explosive mixture is well understood. Without a fuel source and oxygen, there is little opportunity for an ignition source to enable an explosion.

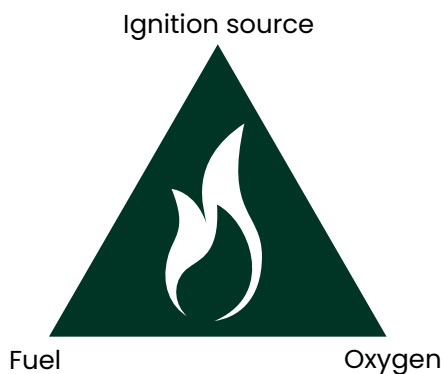

Figure 1: Requirements for combustion

The blanket gas provides the added benefit of mitigating corrosion of the storage vessel and associated equipment, as it removes the moisture that can come in with the ambient air.

A nitrogen purge or blanket can also be found in reactors, to control the amount of oxygen present and to ensure product quality.



Nitrogen is used as the blanket gas as it is inert, relatively inexpensive compared to other options such as carbon dioxide, and readily available. The source of nitrogen is based on the size of the storage vessel or reactor. This can come from an adjacent air separation plant, or if the purged volume is small, from cylinders or dewars.

This article will focus on the benefits of adding an oxygen measurement to the purge process, an overview of the technologies typically used, implementation of the oxygen measurement, and choosing an appropriate partner in implementing the solution. These factors are important whether implementing a purge system for safety or for control of the oxygen concentration. A short list of applications is:

- Storage of hydrocarbon liquids such as Benzene, Hexane, Toluene, Styrene.
- Fire suppression of Biomass fuels.
- Mixing vessels used to dissolve viscous adhesive gels in Hexane.
- Oxidation reaction for Noryl resin suspended in Toluene.
- Oxidation reaction between p-Xylene and acetic acid to make PTA (purified terephthalic acid).
- Industrial centrifuge, separation of makeup solids from hydrocarbon liquid.
- Glove boxes used in all types of medical, biomedical, and pharmaceutical processes.

The inerting process

During storage, transportation, or manufacturing of chemical, biochemical, or organic products, the presence of volatile organic compounds, oxygen, and potential energy sources can lead to fires or explosions. The organic compounds may be needed, as they are part of the process. Eliminating ignition sources is difficult, as ensuring that there is no static electricity stored in the system may not be practical. This leaves the removal of the oxygen necessary to support combustion as the only lever available to mitigate danger.

Inerting and blanketing is applied in closed vessels where there is a head space above a stored product or in a reaction vessel. Nitrogen, typically under slight positive pressure, is added to remove the oxygen that may be present as part of the process or that finds its way into the process from the ambient. The nitrogen may be free-flowing, especially in systems where there is little ability to maintain a positive pressure. In cases where one may maintain a positive pressure, pressure control may limit the amount of nitrogen expended as a blanket. In both examples, there is no assurance that the purged/blanketed space can not support a fire or explosion. Ensuring that there is a safe environment in the head space by over-supplying nitrogen can be quite expensive.

The addition of an oxygen measurement can indicate when there is enough oxygen available to cause a potential hazard. This would feedback to the nitrogen supply system to add nitrogen, or in the case of a gross leak of oxygen into the system, provide an alarm state indication for action to be taken by the operator.

The oxygen measurement can also help control the amount of nitrogen used to blanket the process. It is not necessary to completely remove the oxygen, in most systems. Knowing the oxygen concentration allows the operator to control the nitrogen supply, thus providing a safe condition without waste. In some processes, there may be a need to control the oxygen within a desired range. An oxygen measurement can ensure that the oxygen concentration stays within those limits.

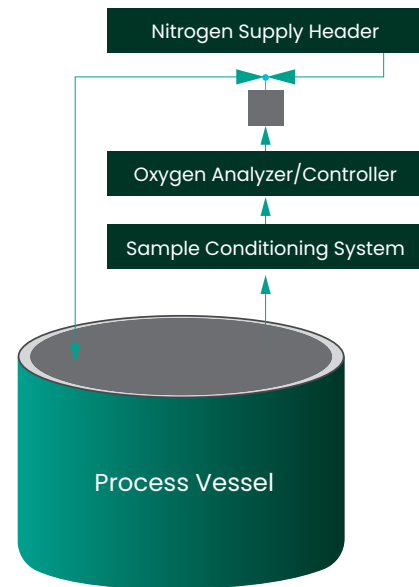

Figure 2: Schematic for tank inerting with O2 analyzer



Oxygen measurement technology

There are several oxygen measurement technologies available for process control. Choosing the oxygen analyzer that best fits any specific application requires an understanding of the various technologies, their relative purchase price, implementation cost, and maintenance requirements. The technologies featured here are among the most commonly used for purge or blanket applications.

Paramagnetic oxygen analyzers

Oxygen is paramagnetic, meaning that it is drawn to a magnetic field. Paramagnetic analyzers take advantage of this property of oxygen.

In a typical paramagnetic oxygen analyzer sensor, two glass spheres are mounted within a magnetic field on a rotating suspension that looks like a dumbbell. A reflective mirror is located at the center of this assembly. Light shines on the mirror and is reflected onto photocells. As oxygen is attracted into the magnetic field, it causes the glass spheres to rotate. The light from the mirror is detected by the photocells. The analyzer's circuit generates a signal to a feedback system, which passes a current to keep the spheres back in their neutral position. This current is directly proportional to the oxygen concentration.

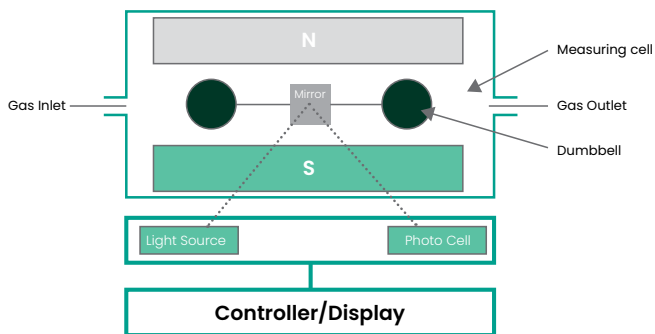

Figure 3: Paramagnetic sensor schematic

An advantage of this technology in this application is that interferences from other paramagnetic gases are not typically present. The sensors are not consumed in making the oxygen measurement. With proper care, the sensor will last for many years. Liquid carry-over can damage the sensor, requiring replacement of the sensor. This sensor typically is used for percent oxygen measurements.

Thermoparamagnetic oxygen analyzers

This technology also makes use of oxygen's paramagnetic properties. It does so without the need for moving parts.

The oxygen molecules are drawn into a magnetic field within and at the center of a measurement cell. This causes a partial pressure difference within the cell. Matched thermistors at an elevated temperature provide a path for the oxygen molecules to leave the magnetic field. The heat from one thermistor in a pair is transferred to the second thermistor in the flow path. The thermistors are in a Wheatstone bridge circuit. The amount of heat transferred from the cooled thermistor to the heated thermistor, and the resultant current required to balance the circuit is directly proportional to the oxygen content present.

With no moving or consumable parts, this technology is less susceptible to upset conditions with liquid carry-over. It is also immune to the typical background gas composition variations found in these applications, as the sensor can compensate for these variations by monitoring for the total heat loss of the thermistors within the Wheatstone bridge.

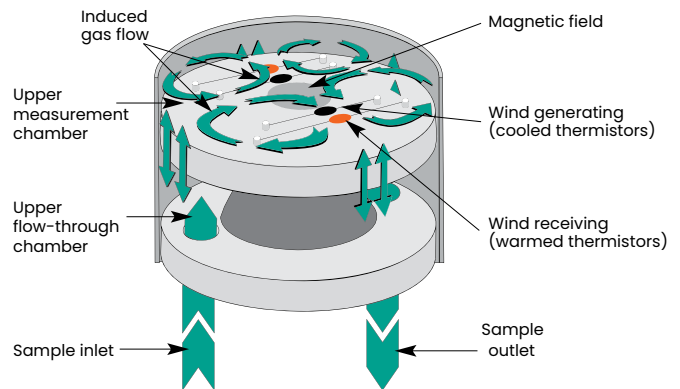

Figure 4: Thermoparamagnetic sensor schematic

The measurement system can be configured to auto-calibrate the sensor using the purge nitrogen as a zero gas. This sensor typically is used for percent oxygen measurements.

The combination of no moving parts, highly stable calibration, auto-compensation for background gas changes, and the ability to mount this in a hazardous area with an auto-calibration sample system and electronics makes this technology most applicable to inerting and blanketing gases where condensing hydrocarbon vapors exist.

Galvanic fuels cell analyzers

With this sensor type, lead (Pb) is consumed by oxygen to produce lead oxide.

The cathode and anode are immersed in solution. The electrons released at the surface of the anode flow to the cathode surface via an external circuit. This current is proportional to the amount of oxygen. The current is measured and used to determine the oxygen concentration in the gas mixture.

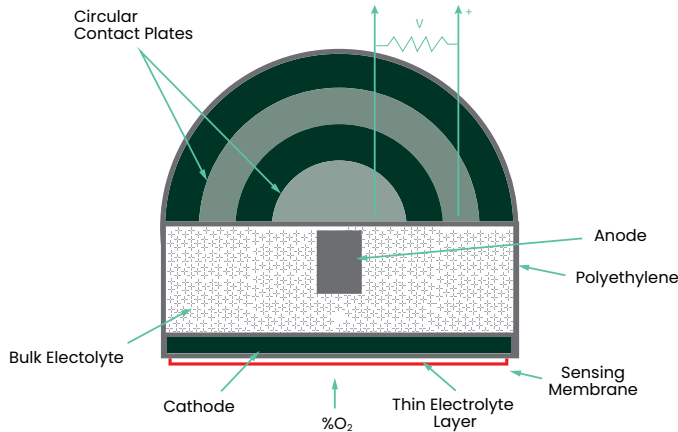

Figure 5: Galvanic fuel cell sensor technology

The reactions at the cathode and anode, along with the overall reaction are shown here.

- Cathode: $O_2 + 2H_2O + 4e^- \rightarrow 4OH^-$
- Anode: $2Pb \rightarrow 2Pb^{+2} + 4e^-$
- Overall: $2Pb + O_2 \rightarrow 2PbO$

Diffusion membranes ensure that the current output is proportional to the oxygen concentration.

This technology provides the benefit a lower cost solution. Since the sensor is consumed in the making of the measurement, spare sensors should be available. Typical life time for the sensor is a couple of years, unless fouled by liquid carry-over, when a replacement will be necessary. The technology is background gas insensitive.

This technology is applicable for both percent-level and ppm-level oxygen measurements. The ppm level sensors are useful for inert atmospheres found in glove-box applications.

Non-depleting electrochemical sensors

This sensor type gives you the flexibility of the galvanic fuel cell with a less intensive maintenance schedule.

When oxygen is present in the sample, a current is produced in the measurement circuit which is proportional to the oxygen concentration. Unlike the galvanic cell, the measurement reaction is driven by an applied voltage across the measurement electrodes supplied from the instrument electronics. The secondary electrodes assist with acid gases and with the speed of response of the measurement.

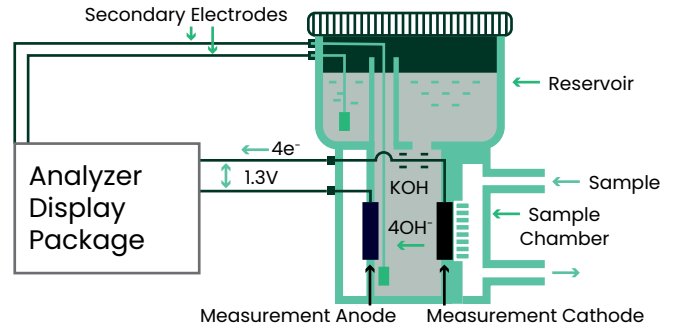

Figure 6: Non-depleting electrochemical sensor

Where ppm or percent level measurements are required, with high level accuracy, and where there is a very low possibility of liquid carry-over, this technology offers stable and fast responding oxygen measurements.

Zirconium Oxide Analyzers

This technology is not often thought of for this application space; but, when the background gas is fairly inert, and speed is a pre-requisite, zirconium oxide sensors offer a simple answer.

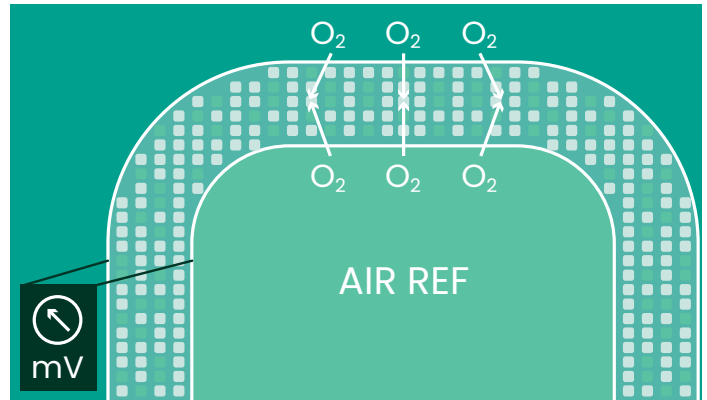

Figure 7: Zirconium oxide sensor schematic

The zirconium oxide sensor is typically in the shape of a test tube. One side is exposed to ambient air as a reference gas and as a source of oxygen molecules. The other side is exposed to the sample gas. The zirconium oxide is doped with yttrium oxide, providing a means for oxygen to migrate through the sensor lattice. The sensor is coated with platinum and operates at an elevated temperature.

The lower the oxygen concentration in the sample gas, the more oxygen molecules migrate through the sensor, causing a change in the electrical voltage across the sensor. The mV reading is measured, and the oxygen concentration is governed by the Nernst Equation.

$$E_{12} = \frac{RT}{nF} \cdot \ln \left[\frac{P_1}{P_2} \right] \quad \text{where,}$$

F = the Faraday = 96,484.56 coulombs

T = absolute temperature = °K
(°K = °C + 273.15°)

R = gas constant =
8.31441 volt-coulomb/mole- °K

n = # electrons transferred
per molecule = 4/mole

ln = natural logarithm = 2.303 log₁₀

P₁ = O₂ partial pressure on
reference gas side = 0.2093

P₂ = O₂ partial pressure
on sample gas side

E₁₂ = voltage on reference with
respect to the sample face

Figure 8: Nernst Equation

The advantages of this sensor type are that it is the fastest responding of the traditional oxygen measurement technologies and the sensor can measure oxygen from percent levels to the sub-ppm region. The disadvantage in many purging or blanketing applications is that it will combust any hydrocarbons with stoichiometric amounts of available oxygen, thus reporting a false low reading. This relegates this technology to applications where the hydrocarbon levels are orders of magnitude below the oxygen concentration.

This sensor is ideal for glove box applications and for measuring oxygen in the nitrogen purge gas prior to injection (where this might be of interest or concern).

Implementing the measurement

It is important to choose the best technology for an application and to choose the most reliable sensor based on that technology. A properly designed sample system ensures that the sensor has the best chance for success. The sample system design should ensure a continuous flow of the sample gas reaches the sensor, and that the sample system does not change the composition of the sample.

For glove box applications, where the nitrogen purge may pick up only small particulates, a simple filter will suffice, if needed at all.

On the opposite side of the spectrum, when purging nitrogen over a hydrocarbon liquid, either in a reactor or in a storage vessel, the extracted sample may carry with it hydrocarbons that will condense. Since liquid hydrocarbons will interfere with the measurement and may damage the sensor, the sample system design should account for the removal of these liquids prior to passing the sensor.

Figure 9 shows a sample system that uses the purge nitrogen as the motive force to pull the sample out of the storage vessel by means of an eductor or aspirator. The gas cools as it enters the sample system, and any condensed liquids drop into the liquid dump. The sample passes through a secondary filter with a bypass drain prior to passing through a thermoparamagnetic oxygen sensor. The drains from the liquid dump and bypass filter, and the outlet from the sensor are carried back to the storage vessel. Since the nitrogen is a perfectly valid zero-gas, the sample system includes solenoid valves powered and controlled by an analyzer (not shown here). The span gas is air. On a timed-basis, the analyzer switches the system to calibration mode, passes the calibration gases through the transmitter, and stores the corrected calibration at the analyzer.

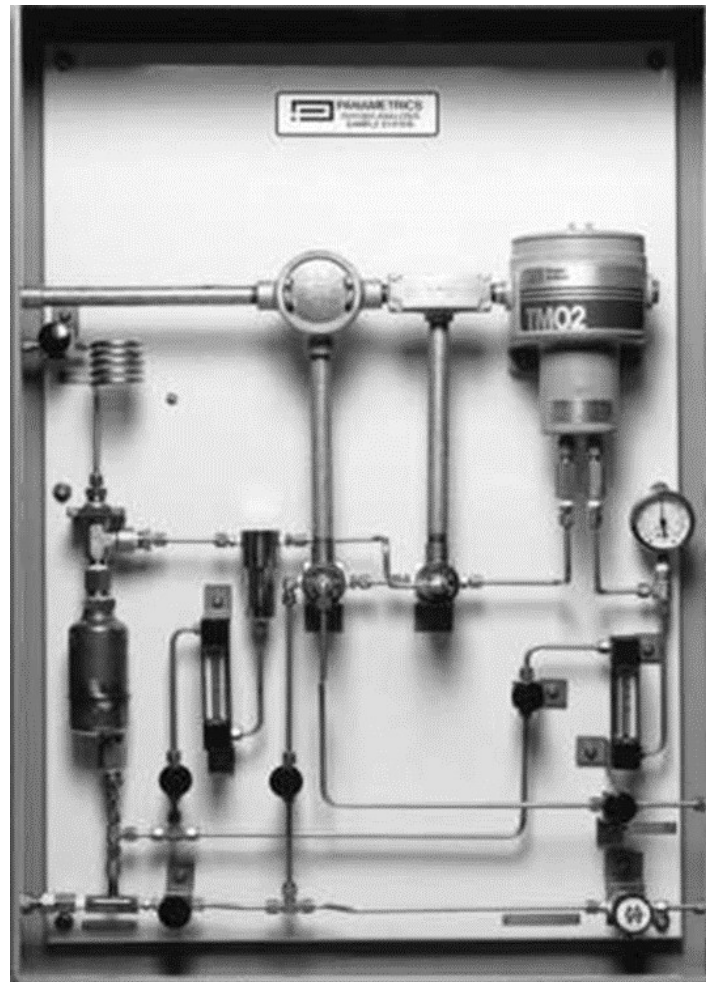

Figure 9: Sample system for tank blanketing

Choosing the right partner

Safety, asset protection, and blanket integrity are vital to plant and process operations. There is a wide range of oxygen measurement technologies and the selection of the correct solution to meet individual challenges requires research and comparison.

The technology needs to be accurate and reliable. It must also be easy to use and maintain. There should be the proper balance between up-front purchase price and the cost to maintain, and these costs should be aligned with the plant's expectations.

The Panametrics applications engineers and product specialists at Baker Hughes understand the need to accurately monitor, measure and analyze the oxygen content in inerting and blanketing applications. We also understand that no two applications are identical. Their portfolio of oxygen analyzers offers our customers multiple technologies, standard and custom-designed sample systems, and a global team of applications engineers and product specialists trained to choose or design a system that meets each specific customer's and application's needs.



About the Author



Narge Sparages

Senior Product Manager

Narge Sparages is the Senior Product Manager on the North America Sales team for Panametrics products and services, at Baker Hughes.